

Polaris Ranger XP900 COMPACT UNDERHOOD CAB HEATER KIT INSTALLATION INSTRUCTIONS

Please read all instructions before beginning installation. When working on cooling systems always allow vehicles to cool to avoid being burned or scalded by hot coolant.

Before working with any electrical system on your vehicle, ALWAYS remove the negative battery cable and secure it away from the battery terminal.

Please check your kit with the parts list and picture below for all required parts.

Qty	Description
1	Heater Unit* (not shown)
1	Heater Mount Bracket
1	Vent Bracket
18'	5/8" Radiator Hose
1	12" (compressed) 2" Duct Hose
1	9" (compressed) 2" Duct Hose
2	6" (compressed) 2" Duct Hose
16	Zip Ties
2	#16 Hose Clamps
6	#10 Hose Clamps
1	1 1/4" Hole Saw
1	2" Hole Saw
1	Pilot Bit
1	Four Pin Connector (not shown)

Qty	Description
1	1" Aluminum Y
1	Thermostat Bypass Valve Kit (BP105)
1	Wiring Loom (3 Pieces Total)
2	Rubber Grommet
2	M6-1.0 x 12mm Flat Head Cap Screws
4	2" Vents
1	3 Speed Fan Switch (switch, bezel, knob)
1	5/8" Shutoff Valve
3	1/4"-20 x 3/4" Serrated Flange HH Bolts
7	1/4"-20 Serrated Flange Nut
1	Garden Hose Adapter
2	Unicoil
1	Five Pin Connector (not shown)



***Note: Heater Unit not shown above**

Cab Heater Installation

Please note: Before drilling holes, check area behind the firewall panel to make sure no damage will occur by drilling holes.

Preparation

1. Disconnect the negative battery terminal from the battery and secure away.
2. Loosen the top dash by extracting the four (4) plastic retaining clips (see Figure 1).

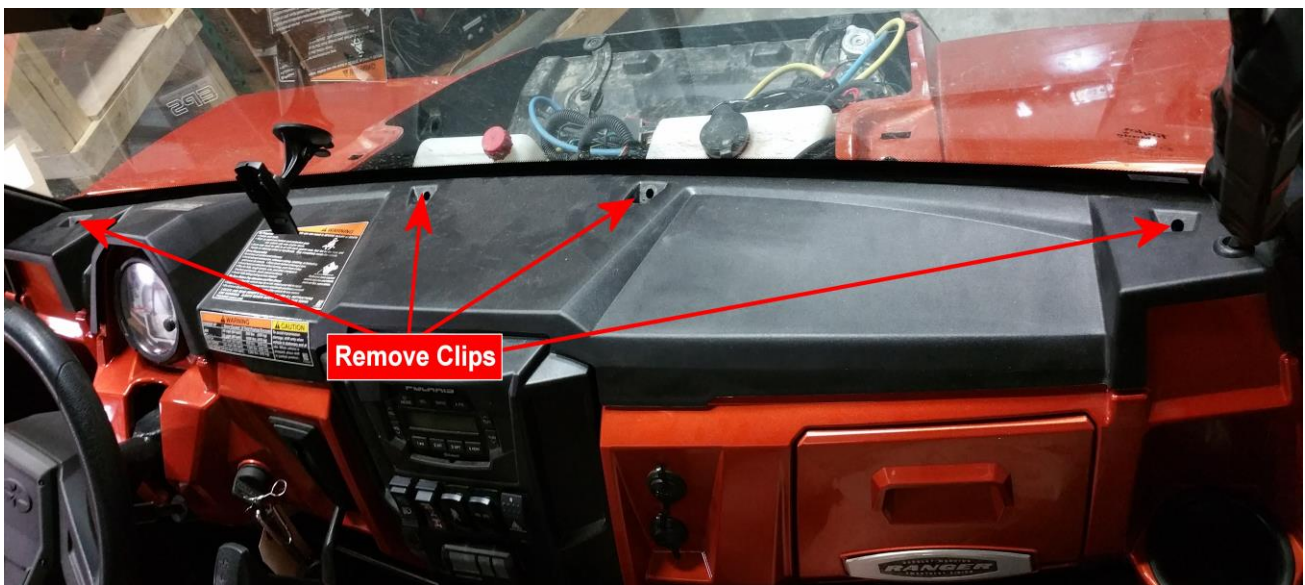

Figure 1

3. Remove the radiator hood by twisting the two retaining knobs; set the radiator hood aside.

4. Remove the center drive shaft tunnel cover by extracting the four (4) plastic retaining clips (see Figure 2); set the tunnel cover aside.



Figure 2

5. Remove the plastic underbody panels to allow easier radiator hose routing in later steps.

Defrost Assembly

6. Cut out and attach the Driver Side Defrost Vent Template (Template #2) and Passanger Side Defrost Vent (Template #3) as seen in Figure 3.



Figure 3

7. Mark the hole centers as shown in Template #2 and Template #3 and drill a 2" hole using the included 2" Hole Saw and Pilot Bit.
Important Note: Clean any burs from around the hole with a debur tool or knife.
8. Insert two of the 2" Vents into the holes until they click firmly into place.
Note: it may be easier to remove the top dash at this point to gain access to the backside of it
9. Attach the 12" piece of 2" Duct Hose to the driver side defrost Vent. Use Zip Ties to secure the Duct Hose.
10. Attach the 9" piece of 2" Duct Hose to the passenger side defrost Vent. Use Zip Ties to secure the Duct Hose.
11. Set the Dash and Duct Hoses to the side.

Switch Wiring

12. Attach the single conductor Red and Black wires (included with kit) to the auxillary power posts found on the passenger side of the front hood area.
 - Mount the Red wire to the Auxillary power post as shown in Figure 4a
 - Mount the Black wire to the Ground Post as shown in Figure 4a

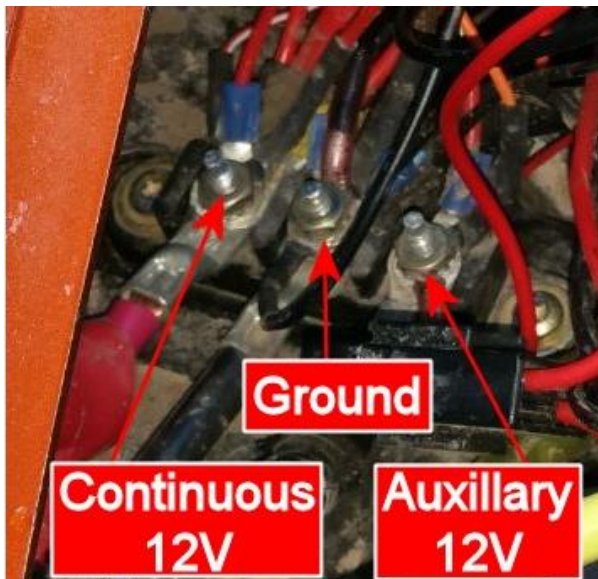

Figure 4a

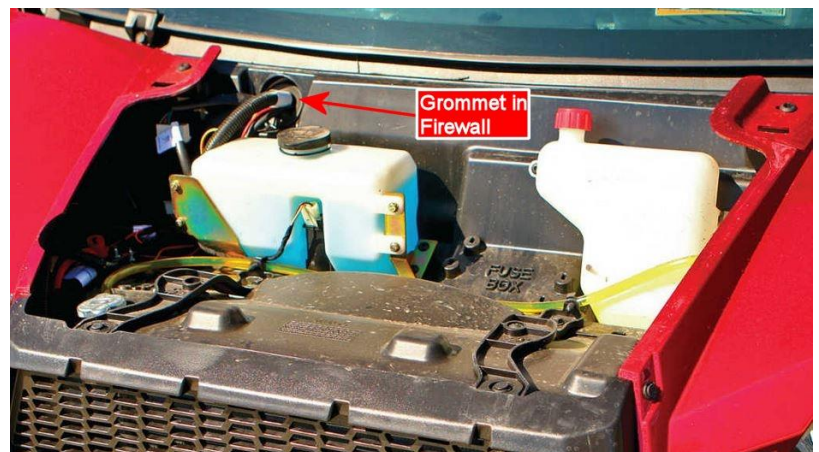

Figure 4b

13. Route the wires through the rubber grommet that is factory installed in the firewall (see Figure 4b for rubber grommet location in firewall). Temporarily set the wires at the top of the dash area.

14. Locate the Three Conductor wiring harness and insert the Yellow, Red, and Orange wires into the Black, Five Pin Connector. If installed properly the terminal will snap into place. If the terminal does not snap, flip it 180 degrees and try again.
15. Locate the Single Conductor Red wire and insert it in the lower left corner of the Black, Five Pin Connector.
16. Connect the assembled connector into the switch housing

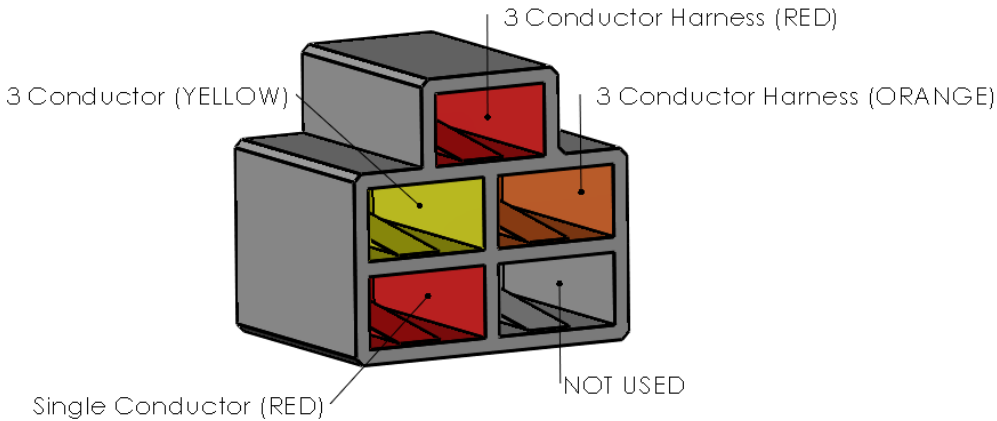

Figure 5

17. Locate the Switch Bezel with the 0,I,II,III markings and cut off the two plastic nubs on the reverse side as shown in Figure 6.
18. Position the Switch Bezel to the right side of the center console as shown in Figure 6.
IMPORTANT NOTE: *Position the Switch Bezel as close to the indicated plastic edge (Figure 6) as possible to eliminate any chance of the switch housing interfering with the glove compartment reinforcement behind the dash.*

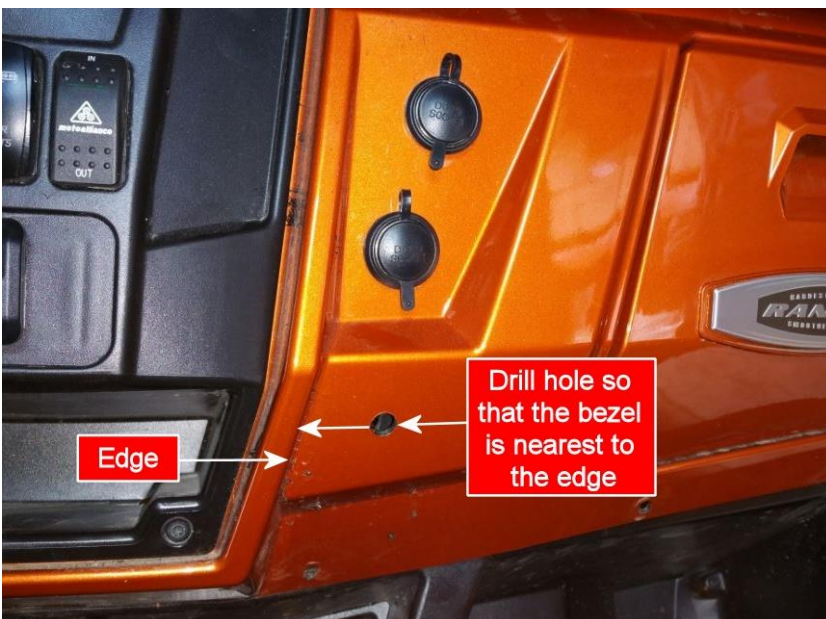

Figure 6

19. Mark the hole center and drill a 7/16" hole as shown in Figure 6.
20. Pass the Fan Switch through the 7/16" hole from the back side of the Center Console. Fit the Switch Bezel over the Fan Switch shaft and orient the Switch Bezel to the flat notch in the Fan Switch Shaft. Loosely connect the Fan Switch and Switch Bezel using the Low Profile Nut included in the switch hardware kit. Discard the spring washer included in the kit.
21. Rotate the Switch Bezel such that the 0,I,II,III markings are oriented upward and the Fan Switch does not hit the glove compartment support plastic on the back side of the center dash and tighten the low profile nut.
22. Press the Fan Switch Knob on to the top of the Fan Switch shaft.
23. Route the four wires from the Fan Switch to the passenger foot well along with the single conductor Black wire connected to the ground terminal in Figure 4.

Coolant Hose Routing

24. Cut out the Heater Mounting Template (Template #1) and attach it to the passenger side firewall following the orientation markings on the template. See Figure 7.
25. Drill the four smaller holes at the designated points on the template using a 5/16" drill bit (not included).
26. Use the 1 1/4" Hole Saw to drill the larger single hole shown in the template.
Important Note: Clean any burs from around the hole with a debur tool or knife.
27. Install a Rubber Grommets into the 1 1/4" hole.



Figure 7

28. Cut out the Center Tunnel Coolant Hose Template (Template #4) and attach it to the firewall at the center of the vehicle and above the drive shaft tunnel.
Note: Before drilling through the firewall, check the area behind the wall to verify that there are no wires behind the cutout area.

29. Using the 1 1/4" Hole Saw drill through the firewall as shown in Figure 8a and 8b.
Important Note: Clean any burs from around the hole with a debur tool or knife.



Figure 8a

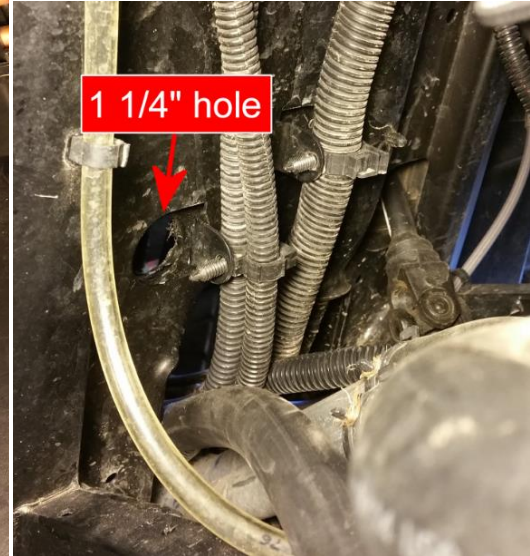

Figure 8b

30. Install a Rubber Grommet into the 1 1/4" hole.
31. Install one of the Unicoil over the 5/8" Radiator Hose. Move the Unicoil on to the hose so that approximately 34" of hose is exposed.
Installation Tip: Install the Unicoil by twisting the Unicoil around the 5/8" hose until the hose extends out of the back of the Unicoil. Grab the exposed hose with your left and the Unicoil with your right hand and pull the Unicoil forward.
32. From the radiator side, push the 34" of 5/8" Radiator Hose through the center tunnel Rubber Grommet and route the 5/8" Radiator Hose toward the passenger footwell.
33. Route the remaining 5/8" Radiator Hose through the drive shaft tunnel (follow the aluminum coolant lines) toward the passenger side of the engine.
34. Route the 5/8" Radiator Hose up to the thermostat housing from the passenger side of the engine. The thermostat housing is located on the engine block just below the two black intake manifolds. Cut the 5/8" Radiator Hose so that it reaches the thermostat housing with an extra 6-12" of hose for any future adjustments.
NOTE: There should be at least 3 feet of extra hose that will be used for the heater outlet.

35. Bend the center tunnel Unicoil at a 90 degree angle keeping it as smooth of a radius as possible. This will reduce the chance of kinking the 5/8" Radiator Hose and help to maintain a smooth transition from the firewall to the center tunnel. See Figure 9.

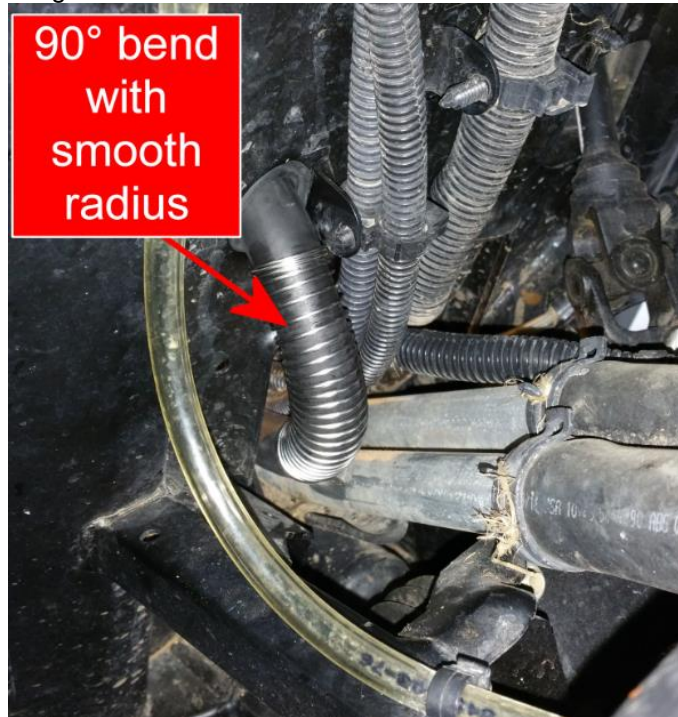

Figure 9

36. Cut the 5/8" Radiator Hose as shown in Figure 10 and insert the 5/8" Plastic Shutoff Valve into the opening with the knob facing upward.
37. Secure with two #10 Hose Clamps.



Figure 10

38. Reinstall the drive shaft tunnel cover as shown in Figure 2.
866.527.7637

39. Install the remaining Unicoil to the excess piece of 5/8" Radiator Hose. Position the Unicoil roughly 2" from one end and bend the Unicoil at a 90 degree angle making as gradual of a turn as possible.
40. Push the long end of the 5/8" Radiator Hose through the remaining Rubber Grommet from the cab side of the firewall until the Unicoil is touching the Rubber Grommet. Leave the hose unattached for now.

In-cab Vent Installation

41. Insert the two remaining 2" Vents into the Vent Bracket until they click.
42. Hold the Vent Bracket up to lower portion of the dash leaving roughly a 1" overlap from the top of the bracket to the bottom edge of the plastic as shown in Figure 11.
43. Mark the hole centers, remove the Vent Bracket and drill the hole locations using a 1/4" drill bit (not included).
Do not install the Vent Bracket yet.



Figure 11

Heater Assembly

44. Set the top dash back into place and hang the two Duct Hoses attached to the 2" Vents down into the passenger footwell.

45. Mount the Heater Unit to the Heater Mount Bracket using the included M6-1.0 x 14mm Flat Head Cap Screws. Note the orientation of the heater relative to the bracket as shown in Figure 12.

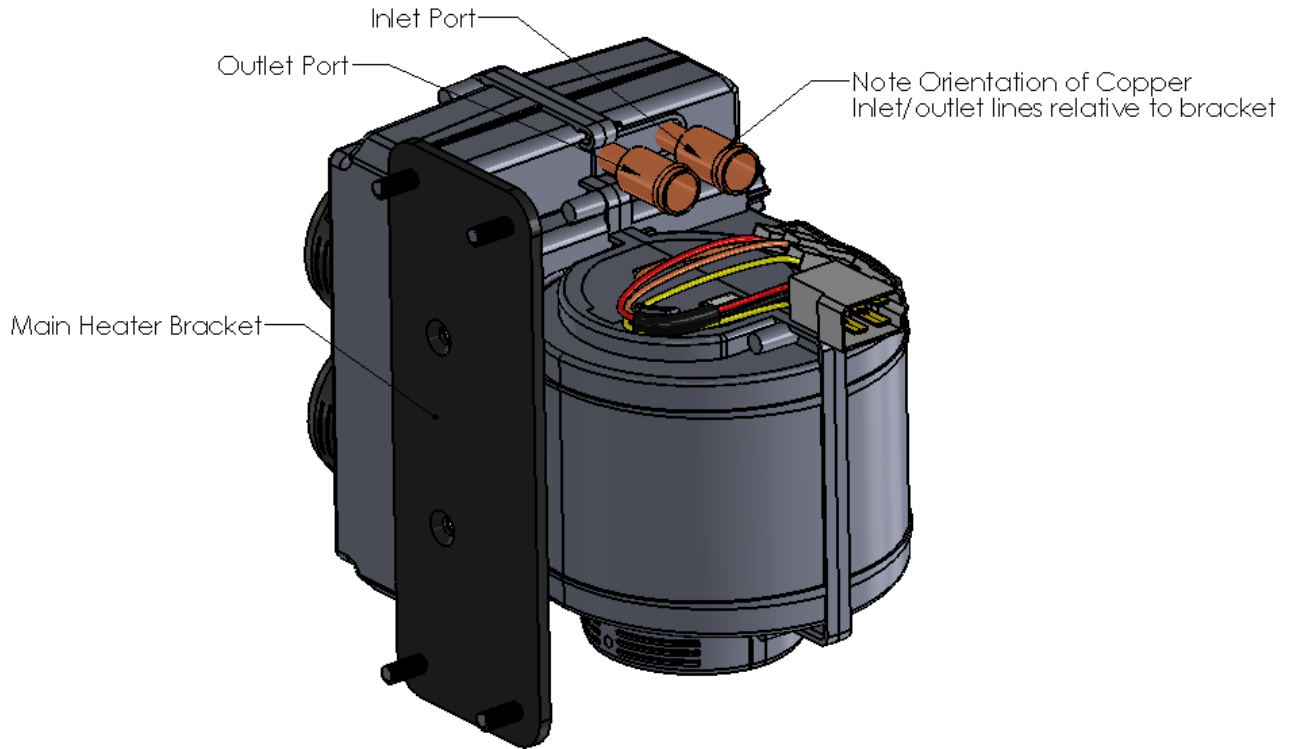

Figure 12

46. Attach the two 2" Duct Hoses coming from the 2" Vents to the back two vent ports (nearest to the firewall). The driver side defrost hose is attached to the lower port and the passenger side defrost hose is attached to the upper port.
Installation Tip: Use a wire cutter to snip the first three coils of the flex hose to better fit over the vent ports. Secure the Duct Hoses using the Zip Ties. See Figure 13.



Figure 13

47. Use the two 6" pieces of Duct Hose and attach them in the same method to the remaining ports.
 48. Position the Heater Unit assembly into the four holes drilled earlier with 4 ports pointed toward the driver side of the vehicle. It will be necessary to pull back on the center console to fit the assembly into the holes.
 49. Secure the assembly using the included 1/4" Serrated Flange Nuts.
 50. Attach the 5/8" Radiator Hose leading from the center tunnel Rubber Grommet to the inlet port on the Heater Unit (see Figure 14). Secure using a #10 Hose Clamp.
 51. Attach the 5/8" Radiator Hose leading from the passenger side firewall Rubber Grommet Hose (See Figure 14) to the outlet port on the Heater Unit (see Figure 14). Secure using a #10 Hose Clamp.
- Installation Tip:** *Position the Unicoil as close to the outlet port and press the opposite end of the Unicoil into the Rubber Grommet if needed.*

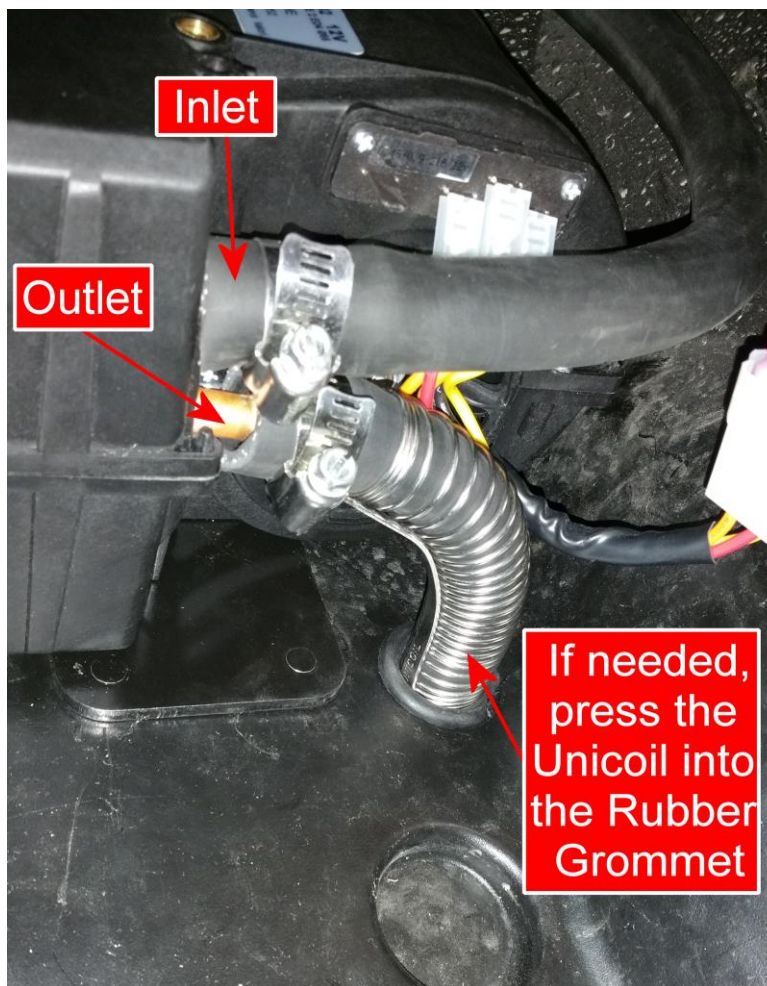

Figure 14

52. Insert the Orange, Red, and Yellow wires into the White, Four Pin Connector in the orientation below. The metal terminals should snap into place if installed properly.
53. Insert the Single Conductor Black wire in the orientation shown below, again ensuring it snaps into position.
54. Connect the assembled connector into the heater plug

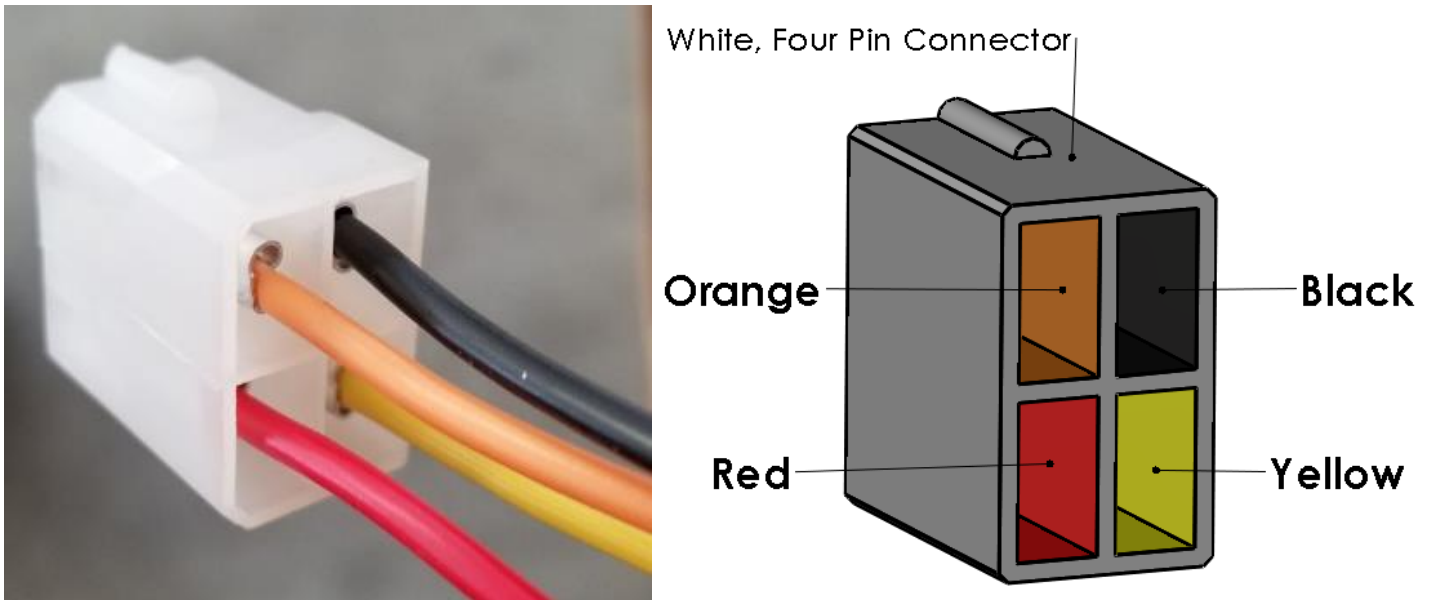

Figure 15

55. Reconnect the negative battery terminal to the battery.
56. Turn the vehicle key to auxillary power and test the fan at each speed to verify everything works properly.
57. Disconnect the negative battery terminal from the battery and secure away.
58. Attach the two 6" Duct Hoses to the back of the Vents already installed in the Vent Bracket.
59. Install the Vent Bracket to the predrilled holes. Use the 1/4"x3/4" Serrated Flange Bolts and Nuts to secure the Vent Bracket to the center console as shown in Figure 16.



Figure 16

Coolant Setup

60. Attach the Garden Hose Adapter to a garden hose.
61. Remove the yellow cover plates (2 screws) from the Garden Hose Adapter.
62. Insert the barbed end of the Garden Hose Adapter into the 5/8" Radiator Hose by the engine's thermostat.
63. Place a bucket under the opposite end of the 5/8" Radiator Hose.
64. Verify that the 5/8" Shutoff Valve installed earlier is in the open position.
65. Fully turn on the garden hose and run water through the cab heater system for at least 1 minute. Empty the bucket as necessary. After 1 minute, allow any residual water to drain from the hoses.

Coolant Hose Installation

66. From the passenger side wheel well, place a bucket under the lower Radiator Hose shown in Figure 17. Cut the Radiator Hose in the middle of the straight section that runs parallel to the radiator.
67. Insert the 1" Aluminum Y with the 5/8" Port facing the Passenger Wheel well. Use two of the larger #16 Hose Clamps to secure the Y as shown in Figure 17.
68. Route the 5/8" Radiator Hose from the Rubber Grommet nearest the Heater Unit to the 1" Aluminum Y leaving a gradual arch in the hose. Cut the hose to length if necessary and secure with a #10 Hose Clamp. See Figure 17.

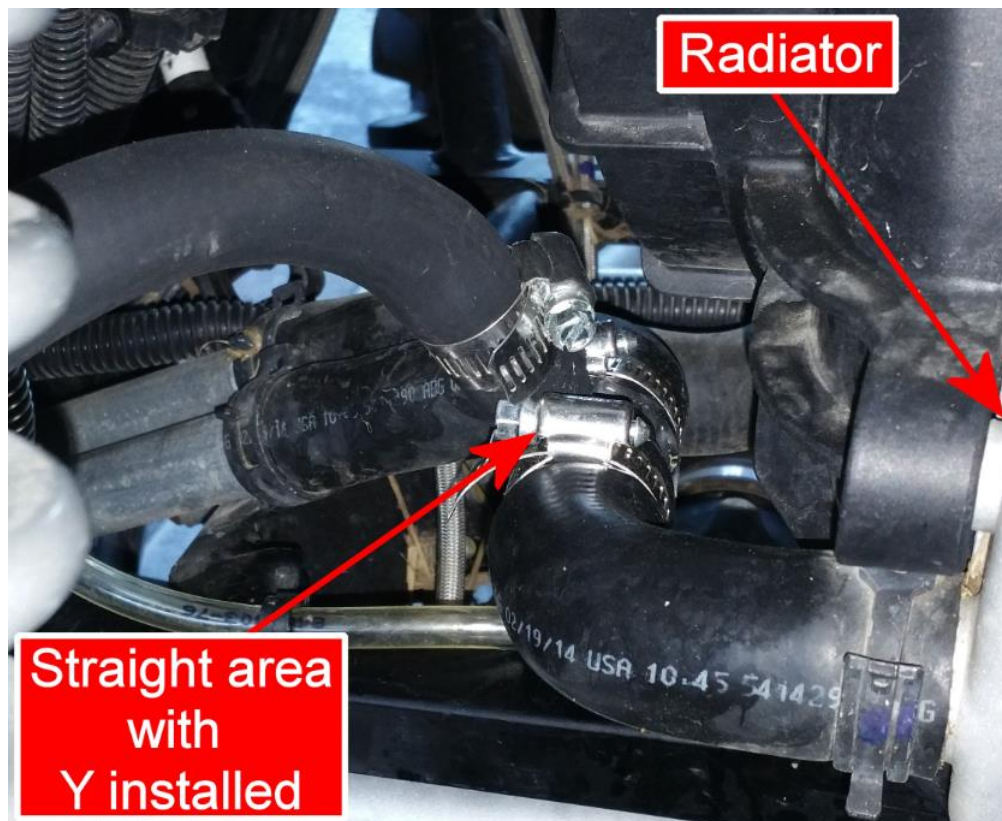
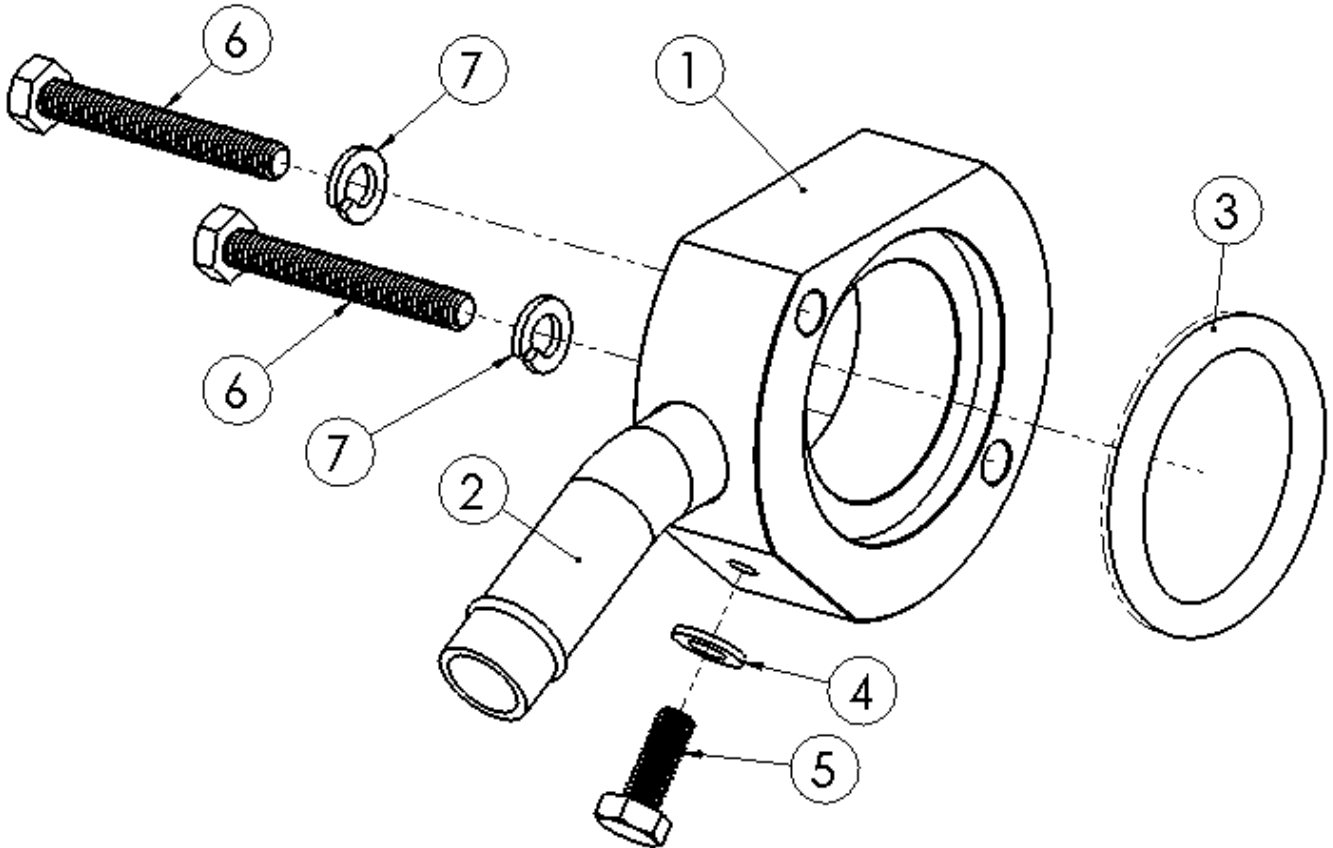

Figure 17

Thermostat Bypass Installation

Please verify that all hardware and parts are included in your package.

Kit Contents:



Item	Description	Qty
1	Thermostat Bypass (BP105)	1
2	5/8" Outlet (welded to Bypass housing)	1
3	2" O-Ring	1
4	M6 Crush Washer	1
5	M6 x 16mm SS HH Bolt	1
6	M6 x 45mm SS HH Bolt	2
7	M6 SS Lock Washer	2

1. Tip the bed of the Ranger to gain access to the engine bay. It may be necessary to unlatch the bed's pneumatic assist cylinder to improve maneuverability.
2. Remove the main air intake hose from the air manifold and set it aside as shown below left in Figure 1.

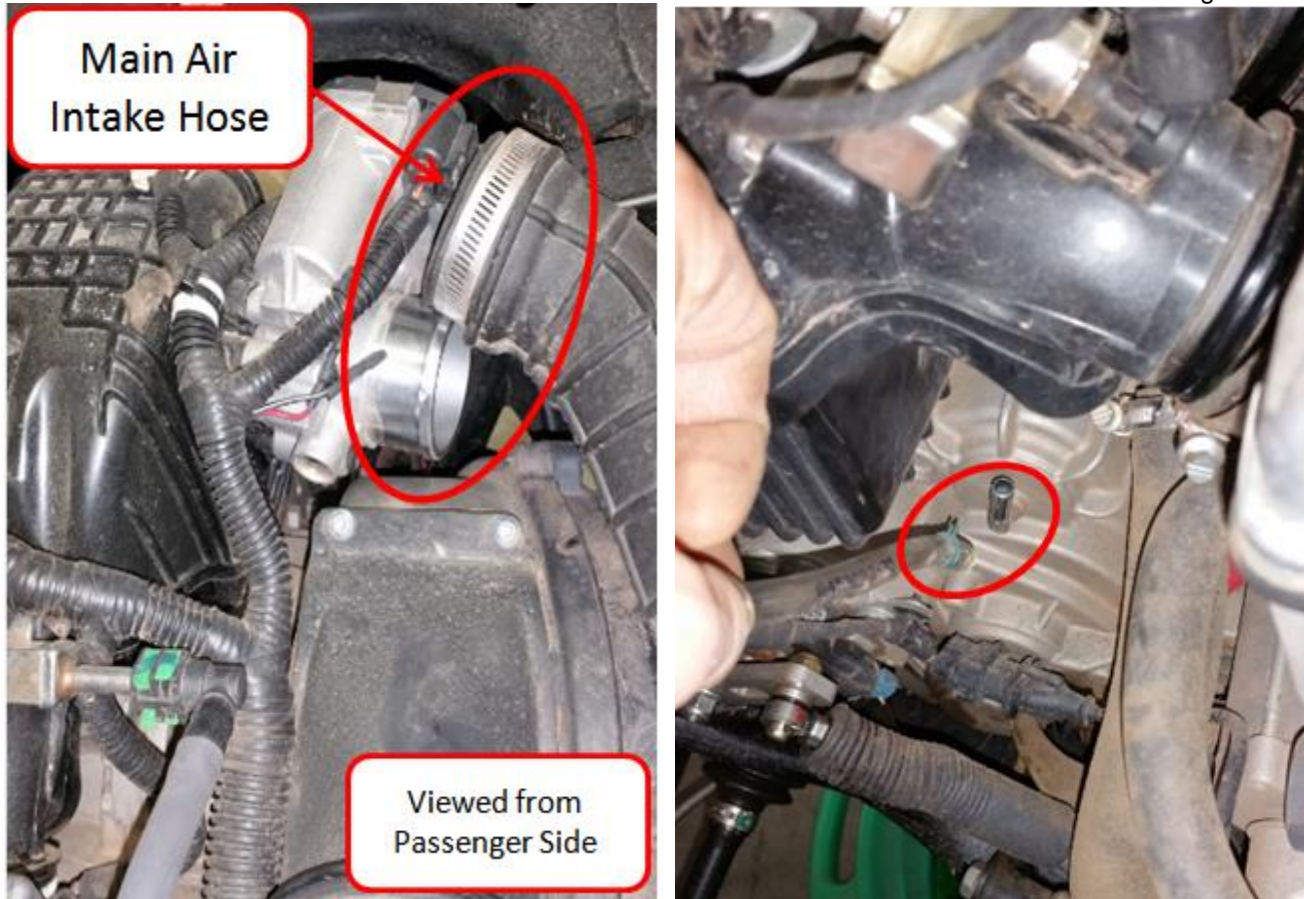

Figure 1

3. Remove the clear plastic hose located below the intake manifolds as shown above right in Figure 1.

4. Use two M13 sockets to completely remove the bottom bolt of the Air Filter Housing located toward the rear of the vehicle. This step can be accomplished with one person; however, if a friend can help hold one of the wrenches it is much easier. See Figure 2.

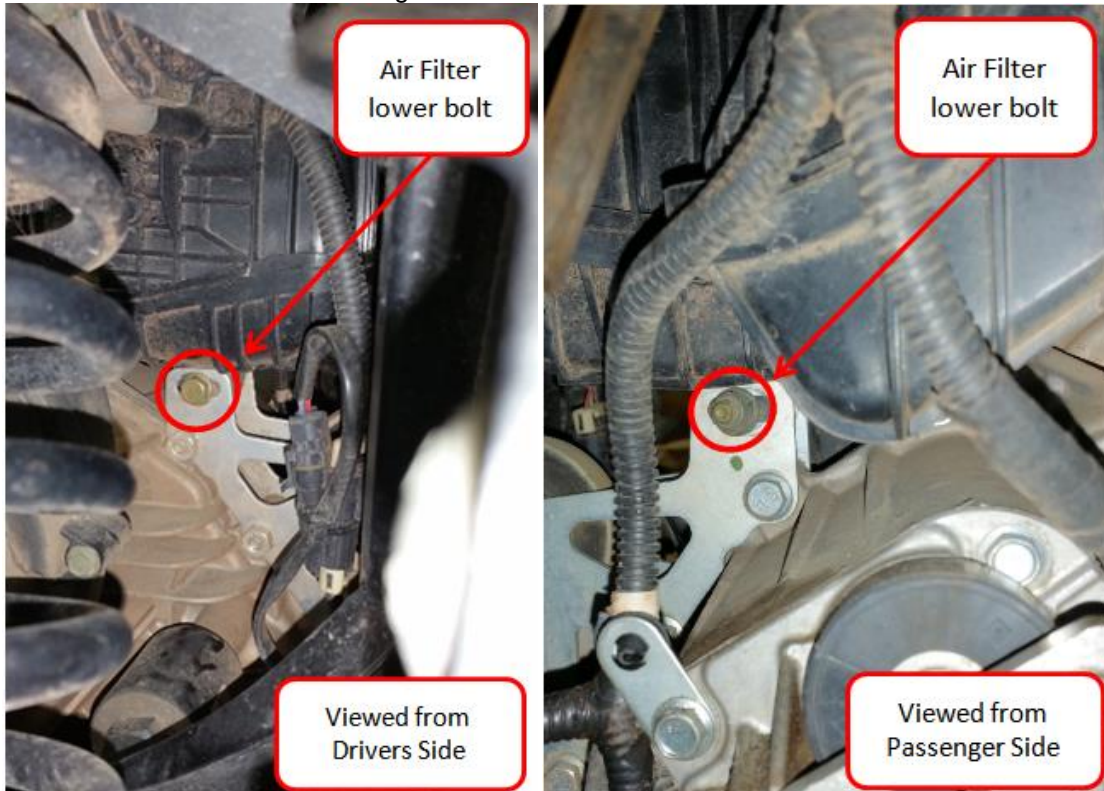

Figure 2

5. Loosen the two hose clamps on the intake manifold as far as possible without causing them to release.

6. Pull the intake manifold assembly away from the engine block to separate the two intakes from the block as shown in Figure 3.
NOTE: *Do not pull on the fuel rail.*



Figure 3

Note: Make sure the vehicle's engine is COLD and always wear safety glasses. Do not proceed if the engine is hot or warm.

7. When the thermostat is removed, fluid will run out of the opening – we suggest you capture any running fluid with a bucket placed under the thermostat location.
8. Remove the thermostat shown in the left side of Figure 4 using an M8 socket wrench (1/4" Drive) from the passenger side of the vehicle.

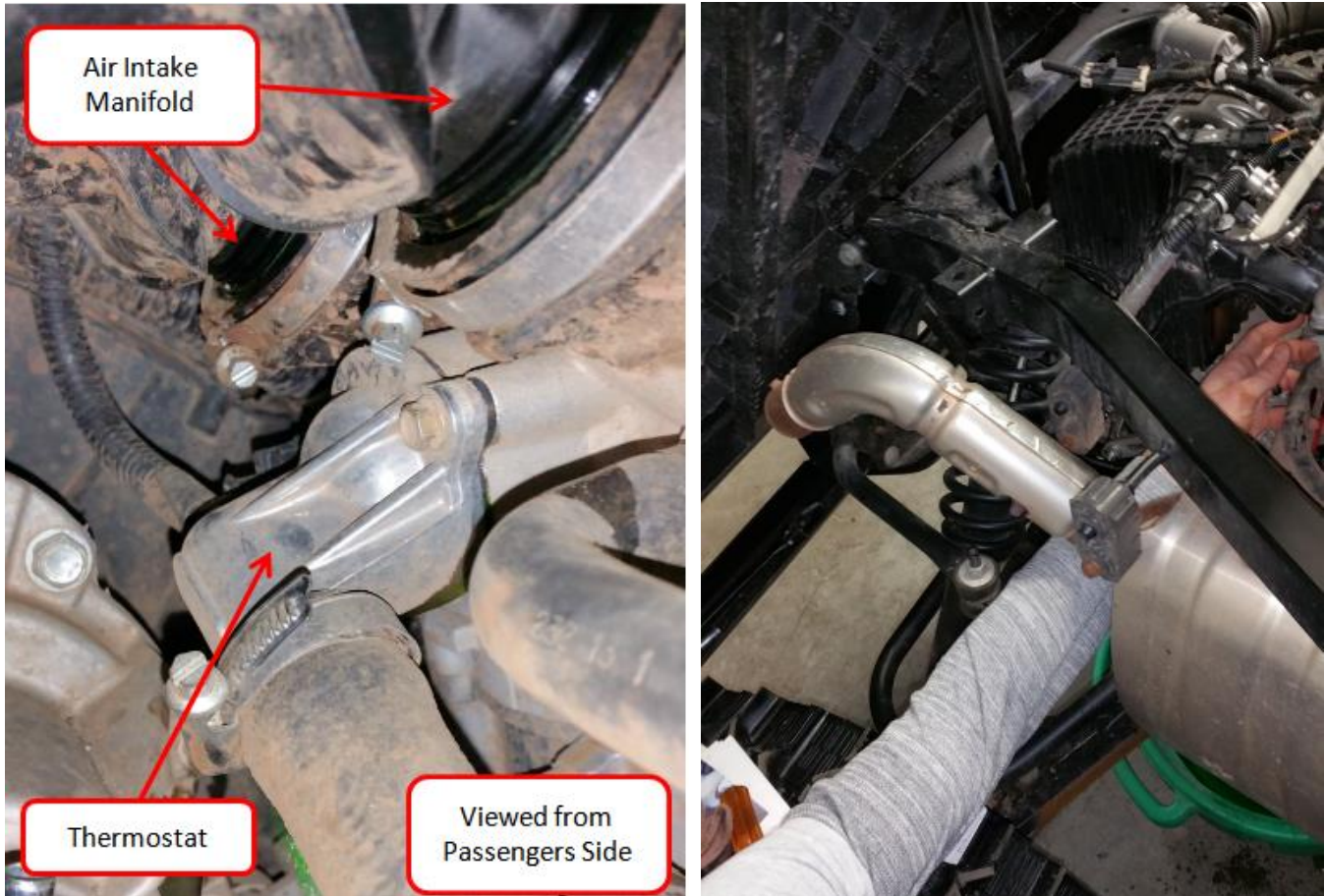

Figure 4

9. After the coolant has stopped draining, assemble the Bypass Valve to the backside of the thermostat (the flat face without a machined groove) using the M6 x 45mm Stainless Steel Hex Bolts so that the 5/8" Outlet on the Bypass Valve is facing the passenger side of the vehicle.
10. Before mounting the thermostat and Bypass Valve, make sure the M6 x 16mm Hex Bolt and Crush Washer are tightened snugly. Also make sure the green 2" O-Ring is placed in the machined slot on the Bypass Valve.
11. Hold the entire assembly up to the engine manifold and install the M6 Bolts by hand at first.
12. Tighten the bolts in an alternating pattern so that the O-Ring is seated with even pressure on the engine manifold.

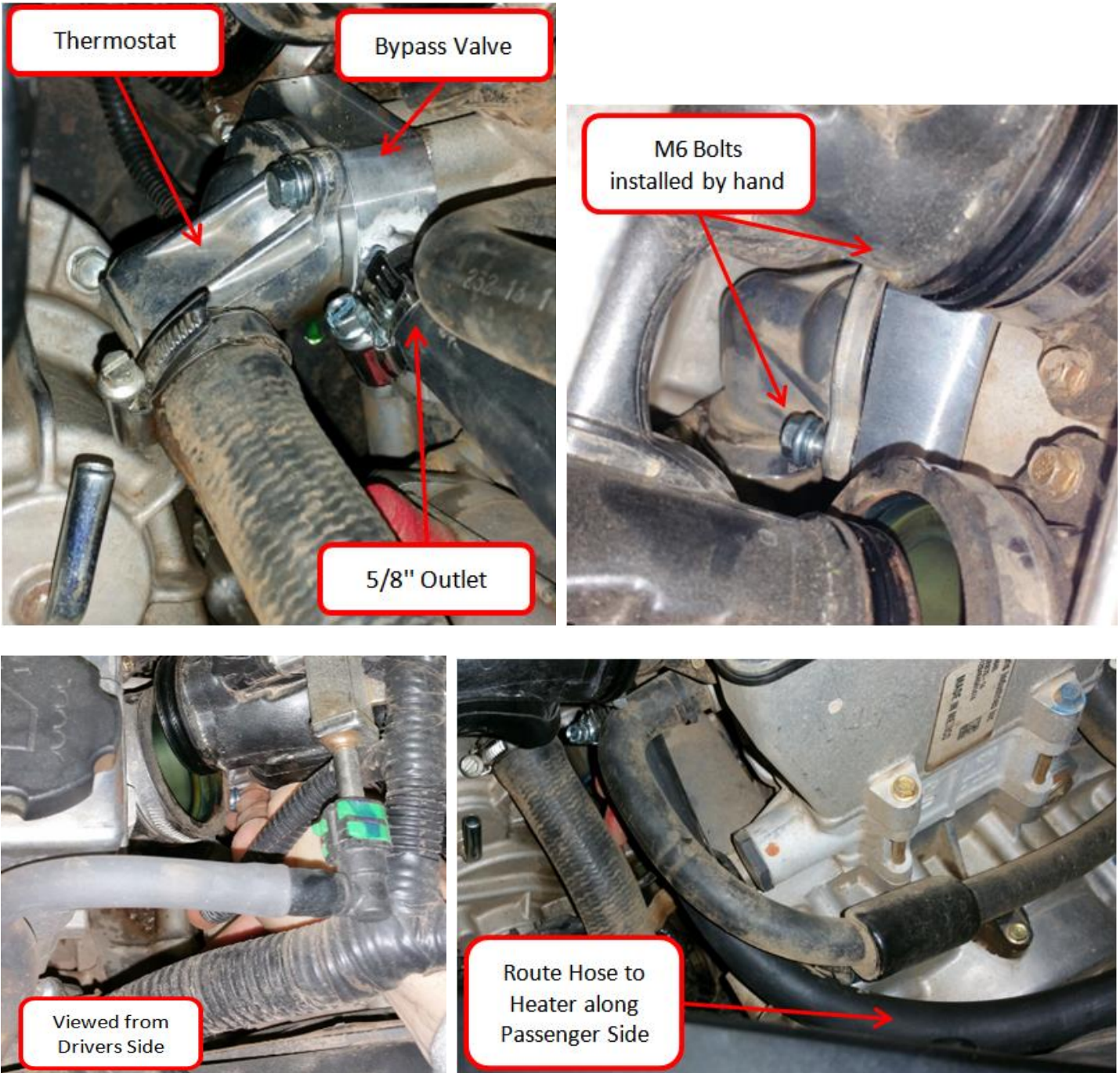

Figure 5

13. Hold the 5/8" Radiator Hose that was routed through the drive shaft tunnel to the 5/8" port on the Thermostat Bypass Valve and trim excess Radiator Hose as needed.
14. Attach the 5/8" Radiator Hose to the Thermostat Bypass Valve and secure it with a #10 Hose Clamp.

15. Use the provided Zip Ties to secure the 5/8" Radiator Hose to the vehicle to keep the hose from vibrating.
16. Reassemble the engine components in reverse order.

Bleeding the Coolant System – Read entire section before proceeding

IMPORTANT NOTE: Some amount of air will have made its way into the coolant system. The following bleeding procedure must be performed to eliminate the air and obtain heat.

The following procedure is most easily accomplished with the help of a partner.

1. Move the vehicle to an area where it can be run. If possible, place the front end of the vehicle on ramps.
2. Open the radiator cap and add as much 50/50 premix coolant as allowable.
3. Turn on the machine and run the engine at 3,000-4,000 RPMS until the radiator fan turns on. During this time, continue to add coolant to the radiator as needed. It is normal for coolant to overflow at times as bubbles move through the system.
4. When the radiator fan turns off, release the accelerator. **If the temperature reaches 205 degrees, turn off the engine and allow the system to cool down.** Once the engine temp reaches approximately 180 degrees, perform steps 3 & 4 again. As air moves out of the system the vehicle's ability to cool itself improves to the point where the radiator fan is able to mitigate the heat generated by the engine. Perform this step for two cycles of the radiator fan. Depending on how much coolant was lost during installation, a third or fourth cycle may be necessary.
5. Close the radiator cap securely. Fill the coolant overflow reservoir to the full line.
6. Again, rev the engine at 3,000-4,000 RPMs for three radiator fan ON/OFF cycles. Turn off the machine and let it completely cool down.
7. In a few hours, check the reservoir level and fill accordingly. Verify that the engine is cold and then open the radiator cap. Fill as necessary. Close the radiator cap.
8. Repeat Step #3 and Step #7 until you no longer see a drop in the coolant overflow reservoir and you feel good heat in the cab after the first radiator fan cycle.
9. Verify there are no coolant leaks.
10. For troubleshooting see the **Supplemental Instructions Important Note** at the beginning of your instructions.